

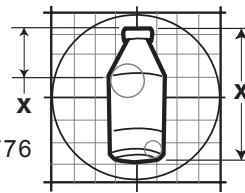

# 084 Package Vending Specification

426 Industrial Boulevard • Kearneysville WV 25430-2776  
 Phone: (304) 728-7056 • Fax: (304) 725-6579



PAGE: 1 of 3
DATE: 6-9-04
REVISION: 03

**PRODUCT NAME:** 12 oz. Aquafina  
**BOTTLER / COMPANY:** Pepsi  
**VOLUME:** 12 oz. / 355 mL  
**PACKAGE TYPE:** PET  
**HEIGHT:** 6.87 in. / 17.4 cm  
**DIAMETER:** 2.55 in. / 6.5 cm  
**WEIGHT:** 0.82 lbs. / 0.38 kg  
**COUNTRY OF ORIGIN:** USA

## APPROVED VENDERS

VENDER	RETAINERS		72" CAPACITY	
	Front	Rear	Front	Rear
EZ	30	N/A	52	N/A
MIV Airflow*	10	see below	26	26
MIV (regular)	11	see below	26	26
TDV	11	18	26	52

\* - Serial number 200422XX00001 and after.

**KITS / PARTS REQUIRED:** **EZ:** 324100 Aquafina 12 oz. Kit EZ. **MIV:** FRONT COLUMNS (72" and 79" vender): 256098 Aquafina 12 oz. Kit Front Merlin IV. REAR COLUMNS: 79" Vender: 256099 Aquafina 12 oz. Kit Rear 79" Merlin IV; 72" Vender: 257099 Aquafina 12 oz. Kit Rear 72" Merlin IV. **TDV:** FRONT COLUMNS: 79" Vender: 296098 Aquafina 12 oz. Kit Front 79" TDV; 72" Vender: 297098 Aquafina 12 oz. Kit Front 72" TDV. REAR COLUMNS: 79" Vender: 296099 Aquafina 12 oz. Kit Rear 79" TDV; 72" Vender: 297099 Aquafina 12 oz. Kit Rear 72" TDV.



## INSTALLATION INSTRUCTIONS:

**Note:** Before working on vender, remove power by unplugging the vender's main power cord from the AC voltage source.

### EZ VENDER (Refer to Figures 2 - 6):

1. Remove product from the column that is to be converted.
2. Remove the wiring cover plate from the front of the vend mechanism assembly (stack).
3. Pull out the product stop holding rod.
4. Remove the existing product stop, and replace it with the small package filler.
5. Reinstall the product stop rod.
6. Replace and secure the wiring cover plate.
7. Fasten a retainer extension to the column's product retainer.
8. Load bottles butt-to-butt, and test vend to ensure product reliability.

### MERLIN IV (Refer to Figures 5 and 7):

1. Remove product from the column that is to be converted.
2. Attach the bottle filler to the product baffle.
3. **Front Columns:** Attach one retainer extrusion to each product retainer. Install retainers in position 10 (Airflow stack) or position 11 (regular stack).  
**Rear Columns:** Place backspacer in position 1 (all the way to the rear). Attach one retainer extrusion to each product retainer. Install retainers in position 10 (Airflow stack) or position 11 (regular stack).
4. Load bottles with caps to the front in front columns and caps to the rear in rear columns.

**ANY QUESTIONS??? CONTACT ROYAL VENDORS' CUSTOMER SERVICE DEPARTMENT  
 CALL TOLL FREE (800) 931-9214**



# 084 Package Vending Specification

426 Industrial Boulevard • Kearneysville WV 25430-2776  
Phone: (304) 728-7056 • Fax: (304) 725-6579

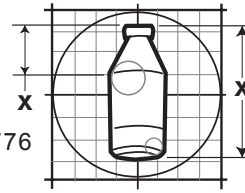

PAGE: 2 of 3

DATE: 6-9-04

REVISION: 03

**PRODUCT NAME:** 12 oz. Aquafina

## TDV (Refer to Figures 1 - 5):

1. Remove product from the column that is to be converted.
2. Remove cover plate from front of vend rack assembly by removing the three screws and lifting the cover plate out.
3. Remove the existing product stop from the column by pulling out the product stop holding rod.
4. Install new product stop in the same position as the old product stop, then insert the rod.
5. Replace vend rack cover plate, and secure it with the screws.
6. Attach one product retainer extrusion to each product retainer. **79" venders only:** Attach the shorter extrusion to the left retainer, and attach the longer extrusion to the right retainer.
7. FRONT COLUMNS: Set the product retainers in position 11, counting from the front.  
REAR COLUMNS: Set the product retainers in position 18, counting from the rear.
8. Load bottles with caps to the front in front columns and butt-to-butt in rear columns.

### Figure 1

Small package filler - front columns of TDV

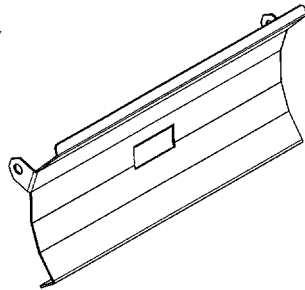

### Figure 2

Small package filler (goes in place of product stop in EZ Venders and in rear columns of TDV)

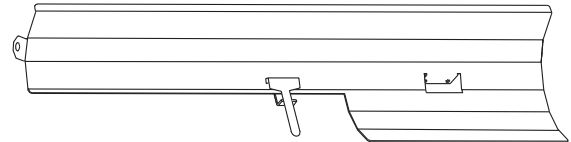

### Figure 3

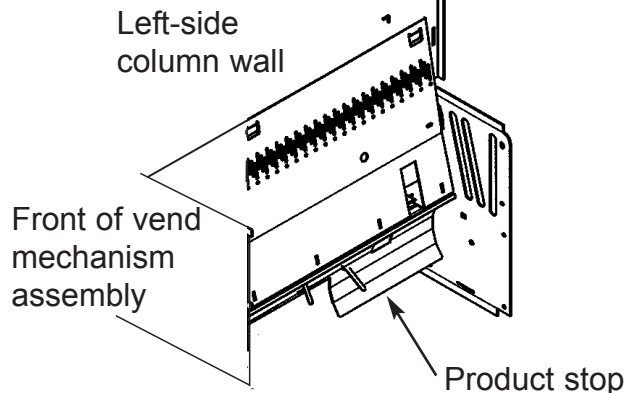

### Figure 4

Front view of column - TDV & EZ Venders

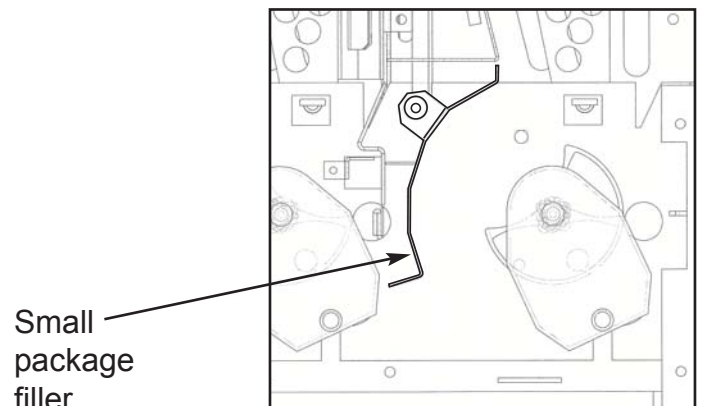

**ANY QUESTIONS??? CONTACT ROYAL VENDORS' CUSTOMER SERVICE DEPARTMENT  
CALL TOLL FREE (800) 931-9214**



# 084 Package Vending Specification

426 Industrial Boulevard • Kearneysville WV 25430-2776  
Phone: (304) 728-7056 • Fax: (304) 725-6579

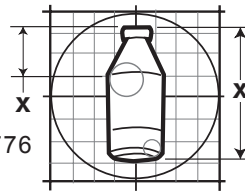

PAGE: 3 of 3
DATE: 6-9-04
REVISION: 03

**PRODUCT NAME:** 12 oz. Aquafina

**Figure 5**

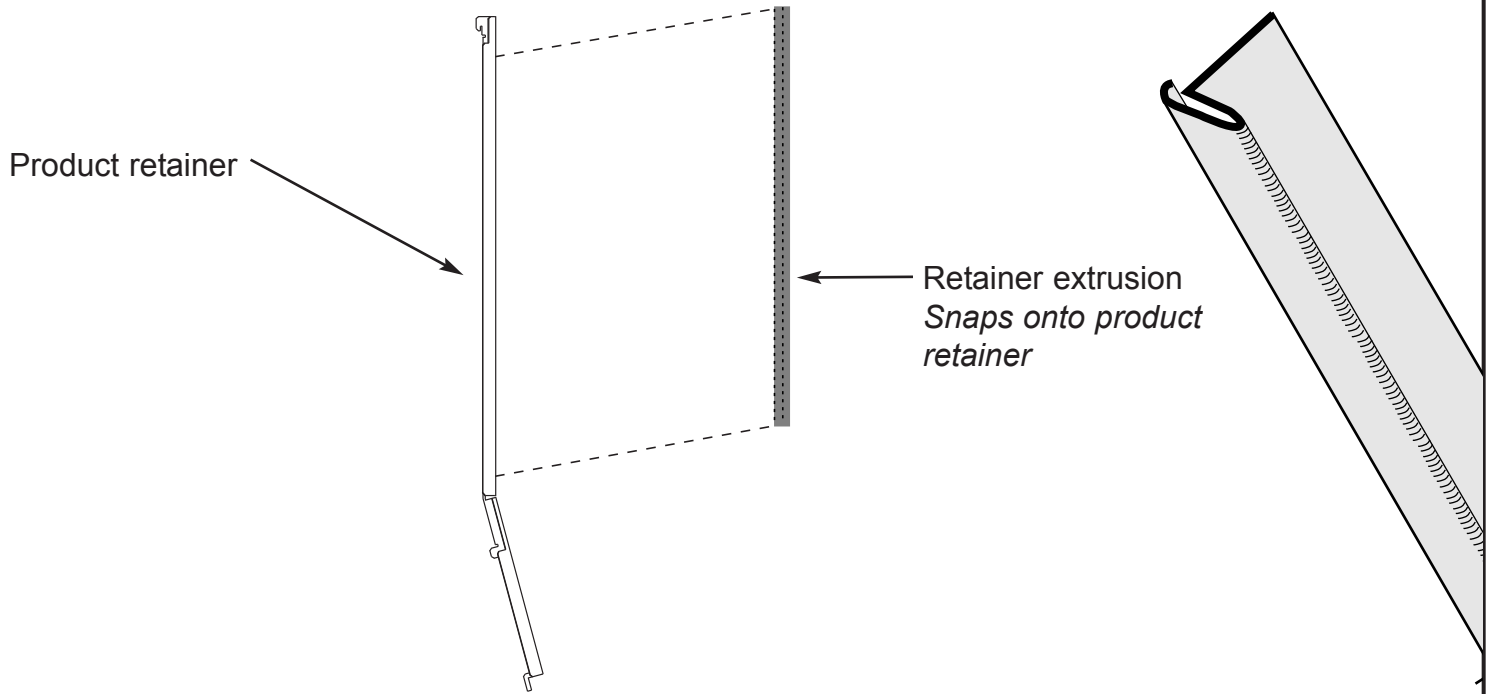

**Figure 6**

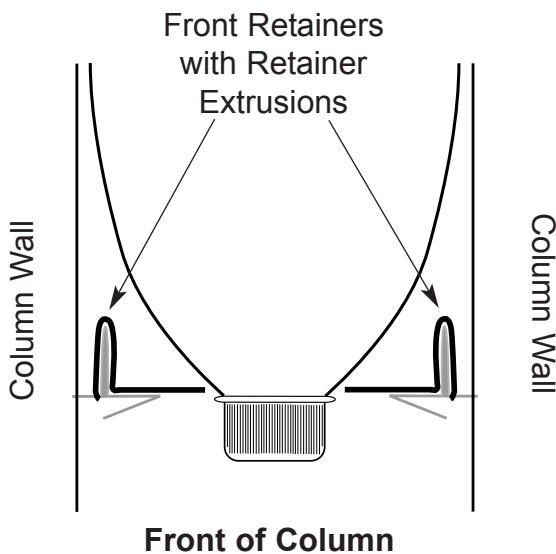

**Figure 7**

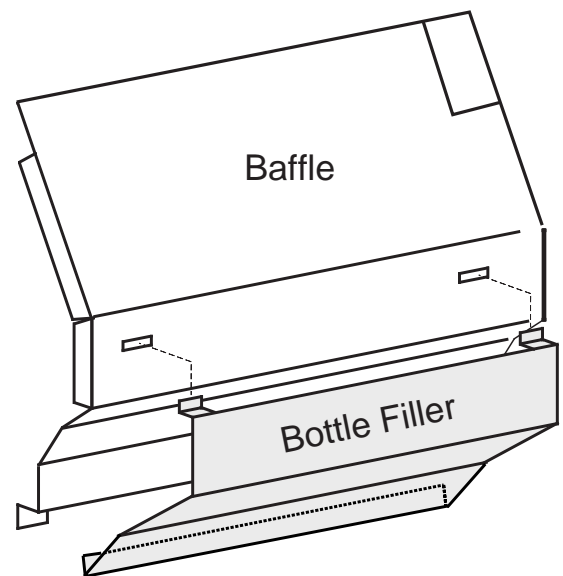

**ANY QUESTIONS??? CONTACT ROYAL VENDORS' CUSTOMER SERVICE DEPARTMENT  
CALL TOLL FREE (800) 931-9214**